

Warranty

PRODUCT WARRANTY

This product includes a 1 year limited warranty. To view our full Warranty Statement, please visit www.camec.com

If your product is faulty or you are experiencing difficulties using this product and require assistance, please contact our warranty department as listed below:

Australia Ph: 1300 654 936 or email camec@camec.com.au

New Zealand: 09 225 1910 or email sales@camec.co.nz



Compact RV Dryer

Capacity: 3.2Kg

P/N: 041834

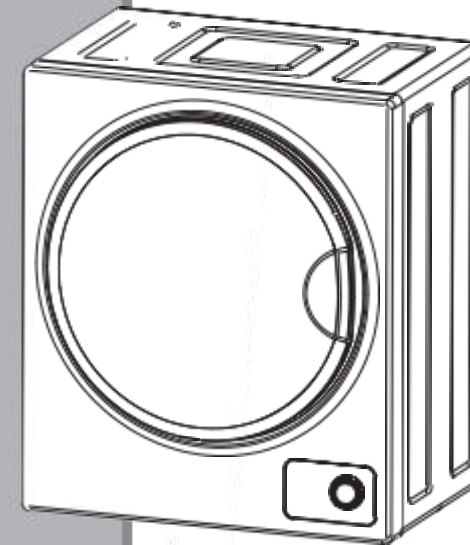

USER MANUAL

Important Safeguards

When using electrical appliances, in order to reduce the risk of fire, electric shock, and/or injury to persons, basic safety precautions should always be followed, including:

For Your Safety

Read all instructions carefully, even if you are quite familiar with the appliance.

- This appliance is not intended for use by persons (including children) with reduced physical, sensory or mental capabilities, or lack of experience and knowledge, unless they have been given supervision or instruction concerning use of the appliance by a person responsible for their safety.
- Young children should be supervised to ensure that they do not play with the appliance.
- INDOOR USE ONLY – this appliance is not intended for outdoor use.
- Do not place naked flame sources, such as candles, on the appliance.
- Do not locate the appliance or cord near heat sources such as radiators, heaters, air ducts or direct sunlight.
- Do not block any of the ventilation openings. Ensure that vents are not covered by newspapers, tablecloths, curtains, etc.
- Do not run the cord under floor coverings. Instead, arrange the cord away from traffic areas where it will not become a trip hazard.
- To disconnect the appliance, turn the appliance off, switch off the power outlet and remove the plug from the power outlet.
- Do not misuse the cord. Never carry the appliance by the cord or pull to disconnect it from the outlet. Instead, grasp the plug and pull to disconnect.
- Do not operate the appliance if it has a damaged cord or plug; after the appliance malfunctions; or has been dropped or damaged in any way. Consult the manufacturer.
- Do not place items that have been soiled with flammable liquids inside the dryer without washing them with detergent thoroughly before hand.
- Do not excessively bend, stretch, twist or bind the power cord or place heavy objects on it.
- This appliance is only to be serviced by a qualified person. There are no user-serviceable parts inside.
- Do not use an extension cord with this appliance.
- Do not overload the tumble dryer.
- Ensure foreign objects do not find their way into the tub of the tumble dryer.
- The door window may be hot after a long drying cycle. Please ensure children are kept away from the machine.
- Do not use flammable or combustible materials such as gas, petrol, alcohol or lacquer in the tumble dryer.
- After turning off the power supply to the tumble dryer, wait at least 2 minutes before turning it back on again.
- Please remove the transport packaging at the rear of the tumble dryer, prior to use.
- If the supply cord is damaged, it must be replaced by the manufacturer, its service agent or similarly qualified persons in order to avoid a hazard.
- Do not attempt to repair, disassemble or modify this appliance. The warranty becomes void if not serviced or repaired by a qualified person.

CAUTION: If this appliance is supplied from a cord extension set or an electrical portable outlet device, the cord extension set or electrical portable outlet device must be positioned so that it is not subject to splashing or ingress of moisture.

Troubleshooting

Review the following pages before calling for service.

Problem	Possible Cause	Solution
Timer knob does not turn dryer on	<ul style="list-style-type: none"> • Is the power cord inserted firmly? 	<ul style="list-style-type: none"> • Insert the power cord firmly • Check the RV's 240V fuse
Drum does not turn	<ul style="list-style-type: none"> • Is the door closed? • Does the dryer have power? • Is the motor operating? 	<ul style="list-style-type: none"> • Close the door. • Check for power as per above. • If motor is operating but drum not turning, replace drive belt.
Hot air is not blowing out	<ul style="list-style-type: none"> • Is the timer incorrectly set on cold air? 	<ul style="list-style-type: none"> • Set the timer to hot air.
The laundry is not thoroughly dried	<ul style="list-style-type: none"> • Are the front and back filters clogged? • Is there too much laundry in the dryer? • Have items been added whilst the dryer is in operation? • Has the laundry become twisted whilst drying? • Has the dryer been placed in a small and badly ventilated area? 	<ul style="list-style-type: none"> • Clean the filters. • Reduce the amount in the dryer. • Increase the drying time. • Untwist the items and re-dry. • Place the dryer in a well-vented area.

SPECIFICATIONS

Model	041834
Drying Capacity	3.2kg
Voltage	220-240V~
Frequency	50/60Hz
Rated Input	850W
Net Weight	17kg
Dimensions	495*410*605mm

NOTE: Consistent with our continuing product development policy, improvements may have been made which render the contents of this package slightly different to that shown.

Maintenance

Cleaning the Lint Filter

Please unplug the power cord prior to any cleaning. The lint filter must be in place whenever drying. It must be cleaned before each use.

1. Removing the filters

Remove by pulling outwards with fingers, inserted into the four holes around the exhaust vent shroud. The filter is in 3 parts: Exhaust vent shroud, lint filter and exhaust filter (as shown in figure 1)

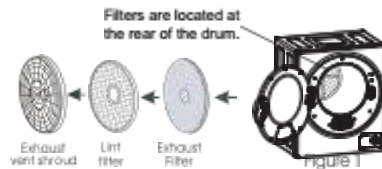

2. Cleaning the filter

Separate "exhaust vent shroud", "lint filter" and "exhaust filter". Clean the lint on the lint filter and exhaust filter with a soft brush or vacuum cleaner. Do not damage the filters (as shown in figure 2)



3. Re-installing the filter

After cleaning, assemble in the sequence of "exhaust filter - lint filter- exhaust vent shroud", align the recesses in the center with the projection in the center of the drum. Make sure that it is firmly inserted (as shown in figure 3).

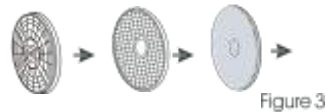

Cleaning of the Air Intake Filter

The filter should be cleaned once a month.

Remove by pulling outwards holding the upper and lower ends of the air intake shroud. Remove the filter behind the shroud and clean it with a soft brush. Reassemble and install as before.

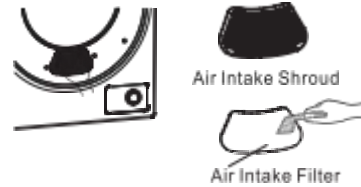

Slightly push upwards with your thumb until the latch hook disconnects, then remove.

Cleaning the interior & exterior of the Dryer

Do not wash directly with water. Do not use thinner, gasoline or alcohol. Do not use any type of spray cleaner when cleaning the interior. If dryer drum becomes stained, clean the drum with a damp cloth. Remove any residue before drying the next load. Clean cabinet with mild soap and water. Do not use harsh or abrasive cleaners, this could damage the dryer.



WARNING: Regularly clean the lint trap



- Oil-affected items can ignite spontaneously, especially when exposed to heat sources such as in a tumble dryer. The items become warm, causing an oxidation reaction in the oil. Oxidation creates heat. If the heat cannot escape, the items can become hot enough to catch fire. Piling, stacking or storing oil-affected items can prevent heat from escaping and so create a fire hazard.

- If it is unavoidable that fabrics that contain vegetable or cooking oil or have been contaminated by hair care products be placed in a tumble dryer they should first be washed in hot water with extra detergent - this will reduce, but not eliminate, the hazard.
- Do not dry unwashed items in the tumble dryer.
- Items that have been soiled with substances such as cooking oil, acetone, alcohol, petrol, kerosene, spot removers, turpentine, waxes and wax removers should be washed in hot water with an extra amount of detergent before being dried in the tumble dryer.
- Fabric softeners, or similar products, should be used as specified by the fabric softener instructions.
- The final part of a tumble dryer cycle occurs without heat (cool down cycle) to ensure that the items are left at a temperature that ensures that the items will not be damaged.
- **WARNING:** Never stop a tumble dryer before the end of the drying cycle unless all items quickly removed and spread out so that the heat is dissipated.

Component Identification

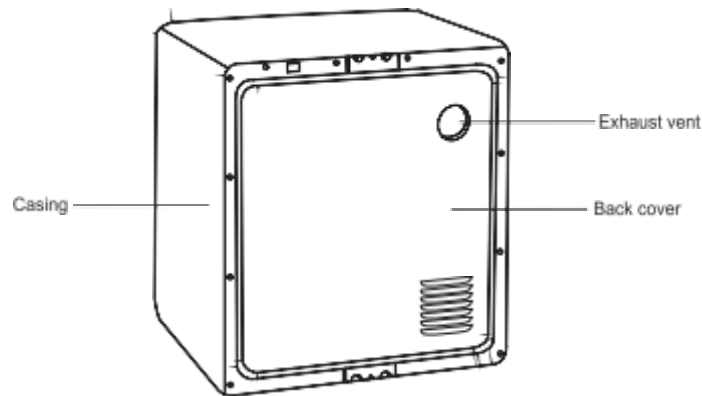
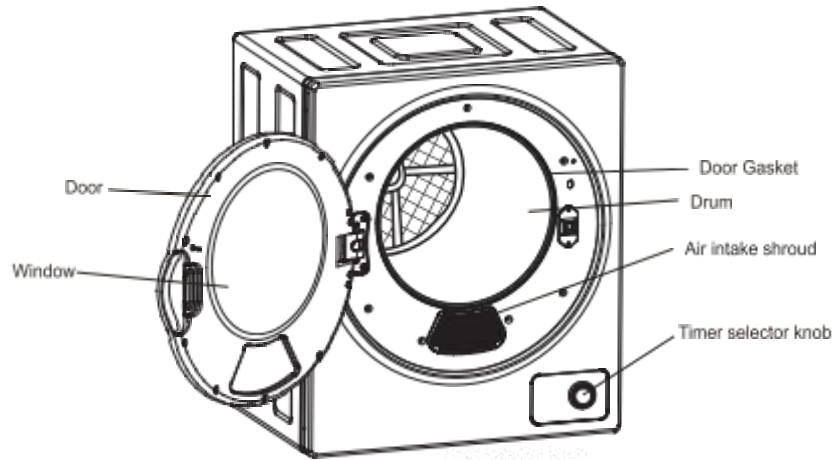

Installation Instructions

For RV mounting, we advise to mount the dryer in a cabinet or shelving with at least 100mm clearance between the rear of the dryer and the wall and 100mm clearance above the dryer.

Ventilation must be supplied either by installing a wall vent directly behind the dryer's rear vent or alternately using the included vent kit to direct the air to an external vent in a different location.

Left/Right-hand door hinging

This dryer is specially designed to be mounted standard (left-hand door hinge) or upside down (right-hand door hinge) so it matches the hinging of the front load washing machine and/or allows the most clearance in a small RV environment.

Two stickers are provided for the selector knob depending on mounting orientation. Simply remove the knob by pulling it off its shaft, apply the appropriate sticker and reinstall the knob.

CABINET STYLE INSTALLATION

Please see installation example below when used in conjunction with a front-load washing machine in a cabinet-style installation. Note a minimum of 100mm clearance is required at the back of the dryer and above the dryer, along with a vent or duct kit.

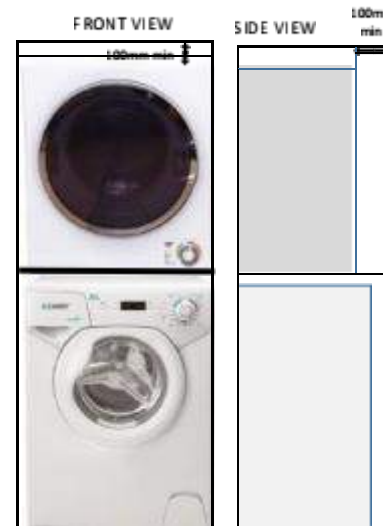

SECURING THE DRYER

If cabinet mounted, M6 bolts (not supplied) can be used to secure the dryer to the mounting shelf using 4 mounting foot locations on the bottom of the machine (indicated on FIG A). Mounting points should be secured at the base of the machine (not from the top). If mounting the dryer upside-down, please secure the dryer with appropriate screws/brackets. Make sure the dryer is checked internally for clearances if screwing through its chassis.

DUCT KIT

This dryer is supplied with duct kit that allows the hot air from the dryer to be routed to an appropriate area or vent. It is installed by attaching one exhaust connector to the rear of the dryer (Fig. A)

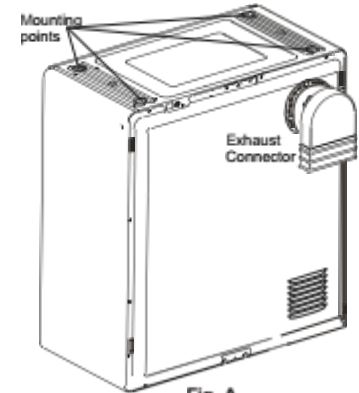

Then connect the flexible hose and stretch to the desired length. The hose can be stretched to a length of up to 1.5m. A second exhaust adaptor is supplied to attach to the exhaust end of the hose if required that can be mounted in front of a vent.

Mounting in other locations.

The dryer should be positioned away from heat and direct sunlight.

If the dryer is not cabinet mounted, it must be placed on firm horizontal ground. Do not place the dryer on carpet as this may block the intake. The dryer comes with fixed legs that need to be screwed in and levelled to ensure stability.

The 'cool down' cycle of tumble dryers should be used to reduce the temperature of the items. They should not be removed from the tumble dryer or piled or stacked while hot.

Items that have been previously cleaned in, washed in, soaked in or spotted with petrol/gasoline, dry-cleaning solvents or other flammable or explosive substances should not be placed in a tumble dryer.

Highly flammable substances commonly used in domestic environments include acetone, denatured alcohol, petrol/gasoline, kerosene, spot removers(some brands), turpentine, waxes and wax removers.

- Items containing foam rubber (also known as latex foam) or similarly textured rubber, like materials should not be dried in a tumble dryer on a heat setting.

Foam rubber materials can, when heated, produce fire by spontaneous combustion.

- Fabric softeners or similar products should not be used in a tumble dryer to eliminate the effects of static electricity unless this practice is specifically recommended by the manufacturer of the fabric softener or product.

- Undergarments that contain metal reinforcements should not be placed in a tumble dryer.

Damage to the tumble dryer can result if metal reinforcements come loose during drying. When available a drying rack could be used for such items.

- Plastic articles such as shower caps or babies' waterproof napkin covers should not be placed in a tumble dryer.
- Rubber-backed articles, clothes fitted with foam rubber pads, pillows, galoshes and rubber-coated tennis shoes should not be placed in a tumble dryer.

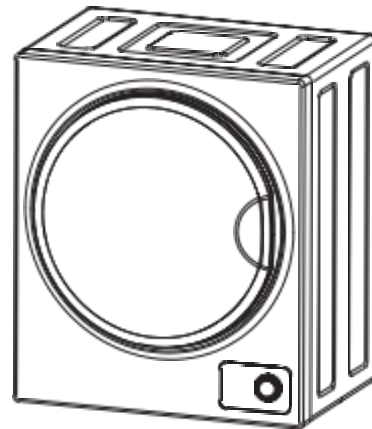

Operating your dryer

Electrical Requirements

The unit is required to be plugged into a three pin socket that is reliably grounded. Plug the power cord into the socket.

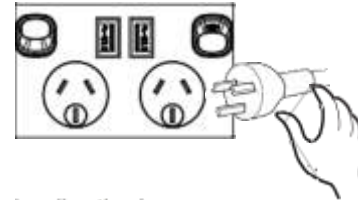

Loading the dryer

It is recommended that items are placed into the dryer one at a time. This ensures they are not tangled which results in uneven drying. When closing the dryer door prior to starting the unit ensure that items are not jammed in the door.

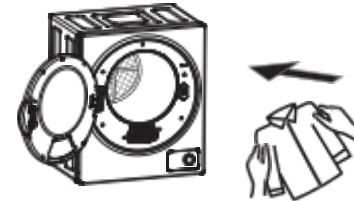

Tips before drying

Prior to loading the dryer check that the items do not have the following the symbols anywhere on them. If they do, do not tumble dry these items.



- Check the items to be dried do not have combustible materials or foreign objects within them i.e. lighters, hair pins, coins.



- Turn items with zippers inside out and fasten buckles.



- Dryer heat may permanently set stains, ensure you check prior to drying that stains are removed.
- Separate dark and light colored items as you would do when washing.
- For best results load the dryer with similar fabrics. Place small delicate items in a mesh bag and do not overload the dryer.
- The maximum mass is **3.2 kilograms** of dry textile material for the dryer and do not overload. The tumble dryer is intended only for drying textile material washed in water.

Drying time reference table

Drying Capacity	Dry time
Approx. 0.5kg	Approx. 30min
Approx. 1.0kg	Approx. 60min
Approx. 2.0kg	Approx. 120min
Approx. 3.2kg	Approx. 200min

Drying times can be affected by many factors, such as material, bulkiness, how full the dryer is etc. The above table is a guide only.

Control Panel Functions

Drying Program Selector

There are three drying combinations available: Cool, Hot and Air dry.

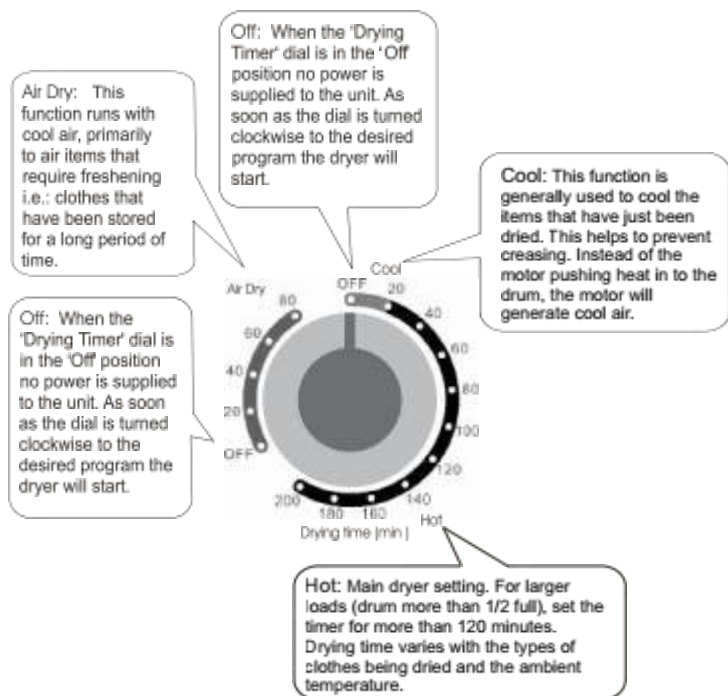

Operation Precautions

Delicate items should be placed into a nylon net bag prior to drying. It is not recommended to dry under wire bras in this unit.



Ensure that foreign objects do not find their way into the dryer. All pockets should be emptied, buttons, buckles and zips fastened. This will also help reduce impact noise when the items hit against the turning drum.



Do not add items into the dryer whilst it is in operation.



If drying large items such as a blanket, it is recommended that from time to time you open the dryer door, shake the item, place the item back in the dryer and close the door. This will ensure even drying.



To ensure you get the most out of the Anti-wrinkle function do not overload the dryer and remove the dried items from the dryer immediately and hang on coat hangers. Iron the items if desired.



To minimize the risk of fire in a tumble dryer, the following should be observed:

- Items that have been spotted or soaked with vegetable or cooking oil constitute a fire hazard and should not be placed in a tumble dryer.

Oil-affected items can ignite spontaneously, especially when exposed to heat sources such as in a tumble dryer. The items become warm, causing an oxidation reaction in the oil. Oxidation creates heat. If the heat cannot escape, the items can become hot enough to catch fire. Piling, stacking or storing oil-affected items can prevent heat from escaping and so create a fire hazard.